

CENNÍK VCHODOVÝCH DVERÍ GEALAN



2012 ★

GEALAN S8000 IQ

DÔLEŽITÉ

Všetky ceny v cenníku sú bez DPH

K dverám vyrábaným zvlášť je potrebné dorátať spojovací profil

V cenníku sú zahrnuté len štandardné farby (orech, zlatý dub, mahagón, bahenný dub nr. 3167 004)

1L – jednostranná laminácia, 2L – obojstranná laminácia

Ostatné farby Vám radi vyceníme u nás

S dverami sú dodávané tri kľúče

Dvere s nadsvetlíkom sú vyrábané z jedného kusa len pri otváraní do vnútra

Na všetky ceny uvedené v cenníku sa vzťahuje dohodnutá zľava

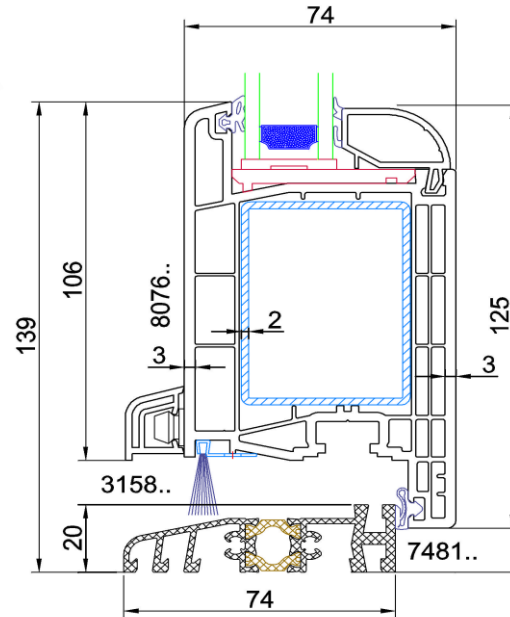

KOVANIE

A,

G - U
SECURY R 4

Dverový zámok s
valcovými čapmi

Nastaviteľné valcové
čapy umožňujú plynulú
reguláciu prítlaku krídla

Uzamykanie:

1, potiahnutím kľučky
dohora (štandardné
zamykanie), bez
príplatku

2, posuv excentrov sa
uskutočňuje pomocou
cylindrickej vložky



B,

G - U
SECURY Automatic

Bezpečnostný
dverový zámok s
masívnymi
závorami

Trojnásobne
uzamknutie dverí po
celej ich výške

Masívne závary
automaticky po
prítláčení krídla uzavrú
dvere v troch bodoch



C,

KFV
AS 2750

Bezpečnostný
dverový zámok s
masívnymi
závorami

Päťbodový
bezpečnostný zámok s
masívnymi uzatváracími
háčkmi.
Odolný proti vypáčeniu



DOPLNKOVÝ TOVAR - KOVANIE

Príplatky za zmenu kovania	CENA
A1 - GU security R4, 5 bodový, potiahnutím kľučkou hore (len pre štítok kľučka/kľučka !!!)	0,00 eur/sada
A2 - GU security R4, 5 bodový, Guľa/Kľučka	46,00 eur/sada
A2 - GU security R4, 5 bodový, Valčekový zámok	56,00 eur/sada
A2 - GU security R4, 5 bodový, Elektrický vrátnik	118,00 eur/sada
B1 - GU security Automatic, 3 bodový, Kľučka/Kľučka	106,00 eur/sada
B1 - GU security Automatic, 3 bodový, Guľa/Kľučka	116,00 eur/sada
C1 – KFV - háky, 3 bodový, Kľučka/Kľučka	135,00 eur/sada
C2 – KFV - háky, 3 bodový, Guľa/Kľučka	145,00 eur/sada
C2 – KFV - háky, 3 bodový, Elektrický vrátnik	212,00 eur/sada

DOPLNKOVÝ TOVAR - PRÍSLUŠENSTVO

NÁZOV	CENA
Samozatvárač bez aretácie	148,00 eur/ks
Samozatvárač s aretáciou	167,00 eur/ks
Bezpečnostná cylindrická vložka s 5 kľúčmi	43,00 eur/ks
Prídavný zámok	148,00 eur/ks
Kukátko	22,00 eur/ks
Príplatok za biely štandardný pánt JOCKER	24,00 eur/ks
Príplatok za hnedý štandardný pánt JOCKER	24,00 eur/ks
Príplatok za bronzový štandardný pánt JOCKER	26,00 eur/ks
Príplatok za biely pánt KOMA	72,00 eur/3ks
Príplatok za hnedý pánt KOMA	72,00 eur/3ks
Príplatok za bronzový pánt KOMA	78,00 eur/3ks
Priečka biela	19,00 eur/m
Priečka jednostranne farebná	22,00 eur/m
Priečka obojstranne farebná	30,00 eur/bm
Zasklievacia lišta biela pre trojsklo	2,00 eur/bm
Zasklievacia lišta farebná pre trojsklo	4,00 eur/m
Držiak AL prahu 8521 (biela, čierna)	8,00 eur/pár

Poznámka: pánt KOMA je robustnejší, má parametre pántu Dr. Hahn

DOPLNKOVÝ TOVAR K MADLÁM

DOPLNKY K MADLÁM	CENA
Montážna sada pre jednostrannú montáž	19,00 eur/ks
Vnútoraná kľučka s krátkym štítkom biela, hnedá	22,00 eur/ks
Vnútoraná kľučka s krátkym štítkom strieborná	26,00 eur/ks
Vnútoraná kľučka s krátkym štítkom bronz	26,00 eur/ks
Vnútoraná kľučka s krátkym štítkom nerez	54,00 eur/ks
Set skrutiek a štvorhranov	2,00 eur/ks
Rozeta bez prekrytia biela, hnedá	19,00 eur/pár
Rozeta bez prekrytia strieborná	26,00 eur/pár
Rozeta bez prekrytia bronz	26,00 eur/pár
Rozeta bez prekrytia nerez	44,00 eur/pár

DOPLNKOVÝ TOVAR - ROZŠIROVACIE PROFILY

Rozširovací profil : Gealan	Biela	1 x farba	2 x farba
20 mm	10,00/ bm	15,00/ bm	18,00/ bm
36 mm do dĺžky 1500mm	11,50/ bm	16,00/ bm	20,50/ bm
36 mm nad 1500mm dĺžky	19,00/ bm	23,00/ bm	28,50/ bm
58 mm do dĺžky 1500mm	18,00/ bm	22,00/ bm	28,00/ bm
58 mm nad 1500mm dĺžky	26,00/ bm	30,00/ bm	36,00/ bm
125 mm	48,00/ bm	56,00/ bm	65,00/ bm

rozširovacie profily od hrúbky 36mm a dĺžky nad 1500mm su dodavane s vystuhou

DOPLNKOVÝ TOVAR - SKLO/PANEL

Príplatky za zmenu skla		CENA
Dubová kôra číra, DKčíra.4/16/4		37 eur/m2
Dubová kôra bronz, DKbronz.4/16/4		48 eur/m2
Flutes pieskovaný, Flutes.p.4/16/4		82 eur/m2
Mliečne, Mat.4/16/4		60 eur/m2
Stopsol broz, číry, šedý, Stopsol.4/16/4		104 eur/m2
Činčila číra, Č.číra.4/16/4		37 eur/m2
Činčila bronz, Č.bronz.4/16/4		48 eur/m2
Bezpečnostné z exteriery 33,1/14/4		52 eur/m2
Bezpečnostné obojstranne 33,1/16/33,1		123 eur/m2
Trojsklo číre 4/12/4/12/4		30 eur/m2
Trojsklo dubová kôra číra, DKčíra./12/4/12/4		70 eur/m2
Teplý rámik, TGI, na dvojsklo		7 eur/m2
Teplý rámik, TGI, na trojsklo		14 eur/m2
Licovanie bočného svetlíka (pre dvere otvárané dnu vyrobené z jedného kusa)	Biela	81 eur/ks
	1 L	92 eur/ks
	2 L	126 eur/ks

Príplatky za dodatočný PVC panel	CENA
PVC panel biely, 24mm	35 eur/m2
PVC panel 1L, 24mm	200 eur/m2
PVC panel 2L, 24mm	242 eur/m2
PVC panel biely, 36mm	78 eur/m2
PVC panel 1L, 36mm	327 eur/m2
PVC panel 2L, 36mm	390 eur/m2

DOPLNKOVÝ TOVAR - SPOJOVACIE PROFILY

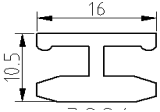
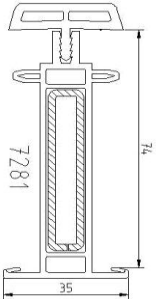
Spojovací profil:	Cena za farbu:
 <p data-bbox="331 437 576 468">typ: 3284 - okenný</p>	<p data-bbox="715 277 1050 311">Biela: 7,20 eur/ bm</p> <p data-bbox="715 350 1121 384">1x farba: 13,50 eur/ bm</p> <p data-bbox="715 423 1066 456">2x farba: 22 eur/ bm</p> <p data-bbox="715 496 938 524">Pozor: cena je za pár</p>
 <p data-bbox="331 874 576 904">typ: 7281 - statický</p>	<p data-bbox="715 605 1070 639">Biela: 40,50 eur/ bm</p> <p data-bbox="715 678 1121 712">1x farba: 46,00 eur/ bm</p> <p data-bbox="715 751 1129 785">2x farba: 63,00 eur/ bm</p>

Pri spájani bočného svetlíka s dverami je vždy použitý statický spojovací profil typ 7281 !!!

DOPLNKOVÝ TOVAR - MADLO OBOJSTRANNÉ

Typ "M-1" 300 mm



Obojstranné madlo:

Lak štandard	56 €/ pár
Lak neštandard	57 €/ pár
Strieborný elox	81 €/ pár
Nerez kartáčovaná	113 €/ pár
Nerez pieskovaná	279 €/ pár
Mosadz	250 €/ pár

Typ "M-2" 300 mm



Obojstranné madlo:

Lak štandard	56 €/ pár
Lak neštandard	87 €/ pár
Strieborný elox	81 €/ pár
Nerez kartáčovaná	113 €/ pár
Nerez pieskovaná	279 €/ pár
Mosadz	250 €/ pár

Typ "M-6" 300 mm



Obojstranné madlo:

Lak štandard	56 €/ pár
Lak neštandard	57 €/ pár
Strieborný elox	81 €/ pár
Nerez kartáčovaná	113 €/ pár
Nerez pieskovaná	279 €/ pár
Mosadz	250 €/ pár

Typ "P-45" 380 mm



Obojstranné madlo:

Nerez	222 €/ pár
-------	------------

Poznámka: lak štandard: RAL 9016, 8019, 9006, 9005

DOPLNKOVÝ TOVAR - MADLO JEDNOSTRANNÉ

Typ "M-1" 300 mm

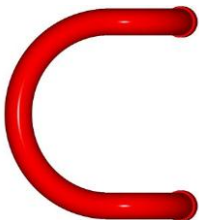

Jednostranné madlo:

Lak štandard	46 €/ ks
Lak neštandard	47 €/ ks
Strieborný elox	59 €/ ks
Nerez kartáčovaná	75 €/ ks
Nerez pieskovaná	158 €/ ks
Mosadz	143 €/ ks

Typ "M-2" 300 mm



Jednostranné madlo:

Lak štandard	46 €/ ks
Lak neštandard	47 €/ ks
Strieborný elox	59 €/ ks
Nerez kartáčovaná	75 €/ ks
Nerez pieskovaná	158 €/ ks
Mosadz	143 €/ ks

Typ "M-6" 300 mm



Jednostranné madlo:

Lak štandard	46 €/ ks
Lak neštandard	47 €/ ks
Strieborný elox	59 €/ ks
Nerez kartáčovaná	75 €/ ks
Nerez pieskovaná	158 €/ ks
Mosadz	143 €/ ks

Typ "P-45" 380 mm



Jednostranné madlo:

Nerez	130 €/ ks
-------	-----------

Poznámka: lak štandard: RAL 9016, 8019, 9006, 9005

Vchodové Dvere GEALAN - Rozmery výplní Dvere otvárajé dnu - v jednom ráme

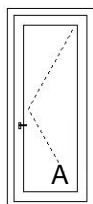

Va

Ša

Ša - 314 [mm]
Va - 280 [mm]

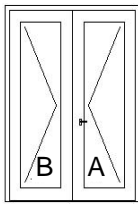

Va

Šb Ša

Ša - 270 [mm]
Šb - 270 [mm]
Va - 280 [mm]

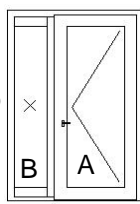

Vb

Šb Ša

Ša - 287 [mm]
Šb - 90 [mm]
Va,b - 280 [mm]
pánty na ráme!!!

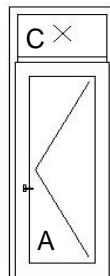

Vc

Va

Ša

Ša - 314 [mm]
Šc - 118 [mm]
Va - 247 [mm]
Vc - 85 [mm]

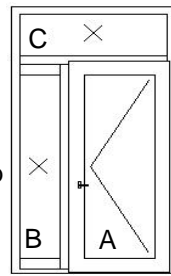

Vc

Va

Šb Ša

Ša - 287 [mm]
Šb - 90 [mm]
Šc - 118 [mm]
Va,b - 247 [mm]
Vc - 85 [mm]

Dvere otvárajé von - na spojovacích profiloch

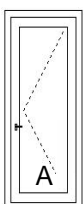

Va

Ša

Ša - 314 [mm]
Va - 280 [mm]

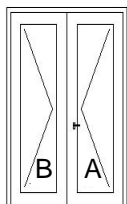

Va

Šb Ša

Ša - 270 [mm]
Šb - 270 [mm]
Va - 280 [mm]

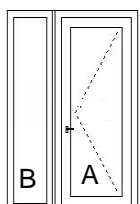

Vb

Šb Ša

Ša - 314 [mm]
Šb - 100 [mm]
Va - 280 [mm]
Vb - 100 [mm]
+ stat. spoj.profil 17mm

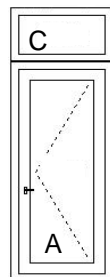

Vc

Va

Šb

Ša - 314 [mm]
Šc - 100 [mm]
Va - 280 [mm]
Vc - 100 [mm]
+ okenny. spoj 2mm

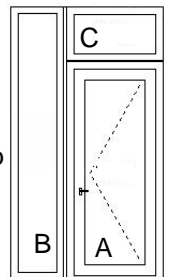

Vc

Va

Šb Ša

Ša - 314 [mm]
Šc,b - 100 [mm]
Va - 280 [mm]
Vc,b - 100 [mm]
+ okenny. spoj 2mm
+ stat. spoj.profil 17mm

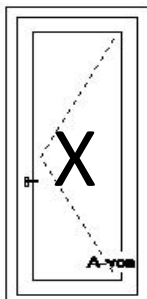

Typ: 1 / bez výplne

Rozmer výplne:

vchodové dvere

Šd - 314 [mm]

Vd - 281 [mm]

terasové dvere

Šd - 256 [mm]

Vd - 231 [mm]

v/Š Farba	900			1000			1100		
	Biela	1L	2L	Biela	1L	2L	Biela	1L	2L
2000	703	840	878	711	852	891	719	863	903
2100	708	850	889	716	862	902	724	873	915
2200	713	860	900	721	871	913	729	883	926

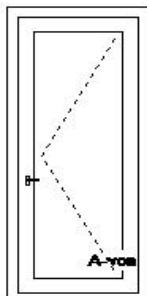

Typ: 2 // číre sklo 4/16/4

Výpočet plochy skla (Ps): $Ps = \dot{S}s \times Vs$ [m²]

$\dot{S}s = \dot{S}d$ [m] - 0,314

$Vs = Vd$ [m] - 0,281

v/Š Farba	900			1000			1100		
	Biela	1L	2L	Biela	1L	2L	Biela	1L	2L
2000	744	881	919	759	899	938	773	918	958
2100	751	893	932	767	912	952	782	931	973
2200	759	906	946	775	925	967	790	944	987

Šd - šírka dverí

Vd - výška dverí

Ps - plocha skla

$\dot{S}s$ - šírka skla

Vs - výška skla

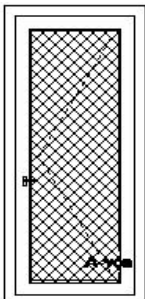

Typ: 3 // panel PVC 24mm

v/š Farba	900			1000			1100		
	Biela	1L	2L	Biela	1L	2L	Biela	1L	2L
2000	778	1083	1161	799	1136	1223	820	1189	1284
2100	788	1107	1189	809	1162	1253	831	1217	1317
2200	797	1131	1217	819	1188	1284	842	1246	1351

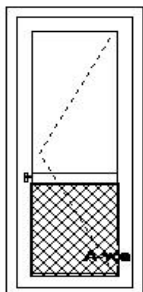

Typ: 4 // 2/3 číre sklo 4/16/4, 1/3 PVC

Výpočet plochy skla (Ps): $Ps = \check{S}s \times Vs$ [m²]

$$\check{S}s = \check{S}d \text{ [m]} - 0,314$$

$$Vs = (2 \times Vd \text{ [m]} - 0,67) / 3$$

v/š Farba	900			1000			1100		
	Biela	1L	2L	Biela	1L	2L	Biela	1L	2L
2000	788	992	1047	807	1025	1084	821	1058	1121
2100	796	1003	1058	814	1036	1099	833	1069	1136
2200	803	1014	1073	821	1047	1110	840	1084	1151

Šd - šírka dverí

Vd - výška dverí

Ps - plocha skla

Šs - šírka skla

Vs - výška skla

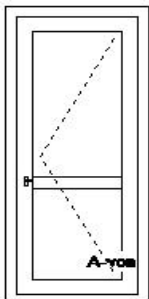

Typ: 5 // číre sklo 4/16/4

Výpočet plochy skla (Ps): $Ps = \check{S}s \times Vs$ [m²]

$\check{S}s = \check{S}d$ [m] - 0,314

$Vs = Vd$ [m] - 0,333

v/š Farba	900			1000			1100		
	Biela	1L	2L	Biela	1L	2L	Biela	1L	2L
2000	773	914	955	788	936	977	807	955	995
2100	781	925	969	799	947	988	814	966	1010
2200	788	940	981	807	958	1003	821	981	1025

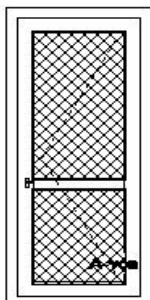

Typ: 6 // PVC 24mm

v/š Farba	900			1000			1100		
	Biela	1L	2L	Biela	1L	2L	Biela	1L	2L
2000	807	1110	1188	829	1162	1251	851	1217	1314
2100	818	1132	1217	840	1191	1280	862	1247	1347
2200	825	1158	1243	851	1217	1314	873	1273	1380

Šd - šírka dverí

Vd - výška dverí

Ps - plocha skla

Šs - šírka skla

Vs - výška skla

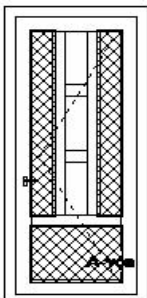

Typ: 7 // 1/3 číre sklo 4/16/4, 2/3 PVC 24mm

Výpočet plochy skla (Ps): $P_s = \check{S}_s \times V_s$ [m²]

$$\check{S}_s = (\check{S}_d \text{ [m]} - 0,418)/3$$

$$V_s = (3 \times V_d \text{ [m]} - 1,329)/4$$

v/š Farba	900			1000			1100		
	Biela	1L	2L	Biela	1L	2L	Biela	1L	2L
2000	969	1232	1306	988	1277	1358	1010	1321	1410
2100	969	1254	1336	999	1299	1388	1021	1347	1439
2200	992	1277	1358	1010	1325	1413	1032	1373	1469

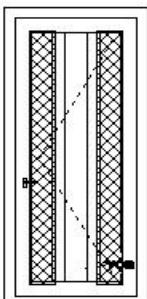

Typ: 8 // 1/3 číre sklo 4/16/4, 2/3 PVC 24mm

Výpočet plochy skla (Ps): $P_s = \check{S}_s \times V_s$ [m²]

$$\check{S}_s = (\check{S}_d \text{ [m]} - 0,418)/3$$

$$V_s = V_d \text{ [m]} - 0,281$$

v/š Farba	900			1000			1100		
	Biela	1L	2L	Biela	1L	2L	Biela	1L	2L
2000	858	1103	1177	873	1143	1221	892	1180	1265
2100	866	1125	1203	884	1166	1247	903	1206	1295
2200	877	1147	1225	895	1188	1273	914	1232	1325

Šd - šírka dverí

Vd - výška dverí

Ps - plocha skla

Šs - šírka skla

Vs - výška skla

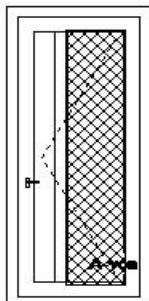

Typ: 9 // 1/3 číre sklo 4/16/4, 2/3 PVC 24mm

Výpočet plochy skla (Ps): $Ps = \check{S}s \times Vs$ [m²]

$$\check{S}s = (\check{S}d \text{ [m]} - 0,366)/3$$

$$Vs = Vd \text{ [m]} - 0,281$$

v/š Farba	900			1000			1100		
	Biela	1L	2L	Biela	1L	2L	Biela	1L	2L
2000	814	1066	1136	833	1106	1180	847	1147	1228
2100	825	1088	1162	840	1129	1206	858	1169	1254
2200	833	1110	1184	851	1151	1232	870	1195	1284

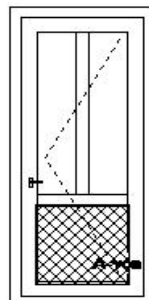

Typ: 10 // 2/3 číre sklo 4/16/4, 1/3 PVC 24mm

Výpočet plochy skla (Ps): $Ps = \check{S}s \times Vs$ [m²]

$$\check{S}s = \check{S}d \text{ [m]} - 0,366$$

$$Vs = (2 \times Vd \text{ [m]} - 0,67)/3$$

v/š Farba	900			1000			1100		
	Biela	1L	2L	Biela	1L	2L	Biela	1L	2L
2000	833	1029	1084	844	1055	1117	858	1084	1147
2100	840	1043	1103	851	1073	1136	870	1103	1169
2200	847	1062	1121	858	1088	1154	877	1121	1191

Šd - šírka dverí

Vd - výška dverí

Ps - plocha skla

Šs - šírka skla

Vs - výška skla

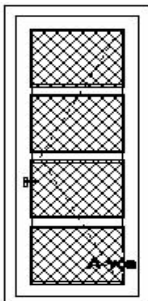

Typ: 11 // PVC 24mm

v/š Farba	900			1000			1100		
	Biela	1L	2L	Biela	1L	2L	Biela	1L	2L
2000	870	1166	1247	892	1221	1288	918	1277	1376
2100	877	1191	1277	903	1247	1317	929	1306	1410
2200	888	1214	1302	914	1273	1346	940	1336	1443

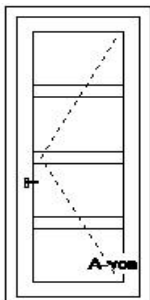

Typ: 12 // číre sklo 4/16/4

Výpočet plochy skla (Ps): $Ps = \check{S}s \times V_s$ [m²]

$\check{S}s = \check{S}d$ [m] - 0,314

$V_s = Vd$ [m] - 0,437

v/š Farba	900			1000			1100		
	Biela	1L	2L	Biela	1L	2L	Biela	1L	2L
2000	866	1010	1055	877	1029	1073	888	1047	1095
2100	870	1021	1066	881	1040	1084	895	1055	1106
2200	873	1032	1077	888	1047	1095	899	1066	1117

$\check{S}d$ - šírka dverí

Vd - výška dverí

Ps - plocha skla

$\check{S}s$ - šírka skla

V_s - výška skla

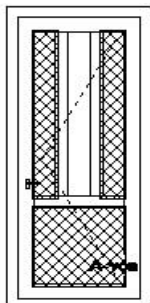

Typ: 13 // 1/4 číre sklo 4/16/4, 3/4 PVC 24mm

Výpočet plochy skla (Ps): $Ps = \check{S}s \times Vs$ [m²]

$$\check{S}s = (\check{S}d \text{ [m]} - 0,418)/3$$

$$Vs = (2 \times Vd \text{ [m]} - 0,67)/3$$

v/š Farba	900			1000			1100		
	Biela	1L	2L	Biela	1L	2L	Biela	1L	2L
2000	881	1147	1221	903	1191	1273	921	1236	1325
2100	892	1169	1247	910	1217	1302	932	1262	1354
2200	903	1191	1273	921	1240	1328	944	1288	1384

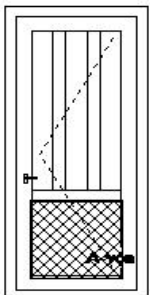

Typ: 14 // 2/3 číre sklo 4/16/4, 1/3 PVC 24mm

Výpočet plochy skla (Ps): $Ps = \check{S}s \times Vs$ [m²]

$$\check{S}s = \check{S}d \text{ [m]} - 0,418$$

$$Vs = (2 \times Vd \text{ [m]} - 0,67)/3$$

v/š Farba	900			1000			1100		
	Biela	1L	2L	Biela	1L	2L	Biela	1L	2L
2000	888	1092	1151	899	1117	1184	914	1143	1214
2100	895	1110	1173	910	1136	1203	925	1162	1236
2200	903	1125	1191	918	1154	1225	932	1184	1258

Šd - šírka dverí

Vd - výška dverí

Ps - plocha skla

Šs - šírka skla

Vs - výška skla

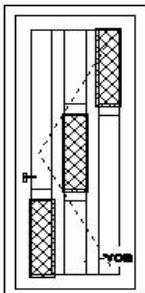

Typ: 15 // 2/3 číre sklo 4/16/4, 1/3 PVC 24mm

Výpočet plochy skla (Ps): $Ps = \check{S}s \times Vs$ [m²]

$$\check{S}s = (2 \times \check{S}d \text{ [m]} - 0,836) / 3$$

$$Vs = Vd \text{ [m]} - 0,385$$

v/š Farba	900			1000			1100		
	Biela	1L	2L	Biela	1L	2L	Biela	1L	2L
2000	992	1180	1243	1003	1206	1273	1018	1232	1302
2100	999	1195	1262	1014	1225	1295	1029	1254	1325
2200	1010	1214	1284	1025	1243	1317	1036	1273	1347

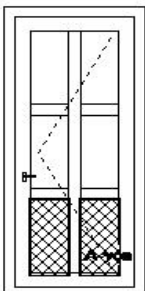

Typ: 16 // 2/3 číre sklo 4/16/4, 1/3 PVC 24mm

Výpočet plochy skla (Ps): $Ps = \check{S}s \times Vs$ [m²]

$$\check{S}s = \check{S}d \text{ [m]} - 0,366$$

$$Vs = (2 \times Vd \text{ [m]} - 0,77) / 3$$

v/š Farba	900			1000			1100		
	Biela	1L	2L	Biela	1L	2L	Biela	1L	2L
2000	951	1136	1195	966	1166	1228	981	1191	1262
2100	958	1151	1214	973	1180	1247	988	1210	1280
2200	966	1169	1232	981	1199	1265	995	1228	1291

Šd - šírka dverí

Vd - výška dverí

Ps - plocha skla

Šs - šírka skla

Vs - výška skla

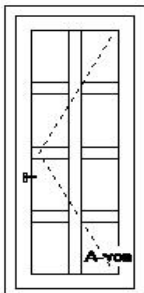

Typ: 17 // číre sklo 4/16/4

Výpočet plochy skla (P_s): $P_s = \check{S}_s \times V_s$ [m²]

$$\check{S}_s = \check{S}_d \text{ [m]} - 0,366$$

$$V_s = V_d \text{ [m]} - 0,437$$

v/š Farba	900			1000			1100		
	Biela	1L	2L	Biela	1L	2L	Biela	1L	2L
2000	1051	1203	1254	1062	1221	1273	1073	1240	1291
2100	1055	1217	1265	1069	1232	1288	1080	1251	1306
2200	1062	1228	1280	1073	1247	1299	1088	1262	1321

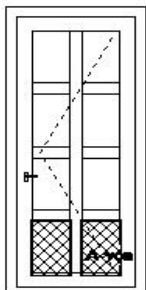

Typ: 18 // 3/4 číre sklo 4/16/4, 1/4 PVC 24mm

Výpočet plochy skla (P_s): $P_s = \check{S}_s \times V_s$ [m²]

$$\check{S}_s = \check{S}_d \text{ [m]} - 0,366$$

$$V_s = (3 \times V_d \text{ [m]} - 1,3) / 4$$

v/š Farba	900			1000			1100		
	Biela	1L	2L	Biela	1L	2L	Biela	1L	2L
2000	1032	1221	1280	1047	1251	1310	1062	1277	1339
2100	1040	1236	1299	1055	1265	1328	1069	1291	1358
2200	1047	1251	1314	1062	1280	1347	1080	1310	1380

\check{S}_d - šírka dverí

V_d - výška dverí

P_s - plocha skla

\check{S}_s - šírka skla

V_s - výška skla

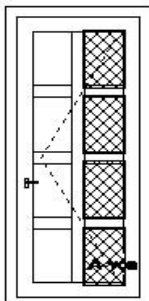

Typ: 19 // 1/2 číre sklo 4/16/4, 1/2 PVC 24mm

Výpočet plochy skla (Ps): $Ps = \check{S}s \times Vs$ [m²]

$$\check{S}s = (\check{S}d \text{ [m]} - 0,366)/2$$

$$Vs = Vd \text{ [m]} - 0,437$$

v/š Farba	900			1000			1100		
	Biela	1L	2L	Biela	1L	2L	Biela	1L	2L
2000	1018	1240	1306	1032	1277	1347	1051	1314	1391
2100	1025	1258	1328	1043	1295	1369	1062	1332	1413
2200	1032	1277	1347	1051	1314	1391	1069	1354	1436

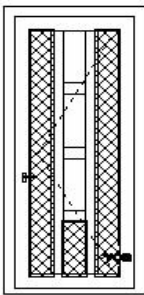

Typ: 20 // 1/4 číre sklo 4/16/4, 3/4 PVC 24mm

Výpočet plochy skla (Ps): $Ps = \check{S}s \times Vs$ [m²]

$$\check{S}s = (\check{S}d \text{ [m]} - 0,418)/3$$

$$Vs = (3 \times Vd \text{ [m]} - 1,3)/4$$

v/š Farba	900			1000			1100		
	Biela	1L	2L	Biela	1L	2L	Biela	1L	2L
2000	973	1232	1310	992	1277	1362	1010	1321	1413
2100	984	1258	1336	1003	1302	1391	1025	1347	1443
2200	995	1280	1362	1018	1328	1417	1036	1376	1473

Šd - šírka dverí

Vd - výška dverí

Ps - plocha skla

Šs - šírka skla

Vs - výška skla

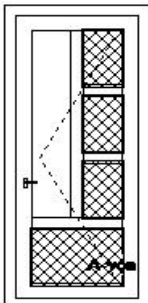

Typ: 21 // 3/8 číre sklo 4/16/4, 5/8 PVC 24mm

Výpočet plochy skla (Ps): $P_s = \check{S}_s \times V_s$ [m²]

$$\check{S}_s = (\check{S}_d \text{ [m]} - 0,366)/2$$

$$V_s = (3 \times V_d \text{ [m]} - 1,0)/4$$

v/š Farba	900			1000			1100		
	Biela	1L	2L	Biela	1L	2L	Biela	1L	2L
2000	892	1125	1195	910	1243	1227	929	1206	1288
2100	899	1147	1217	921	1265	1252	940	1232	1317
2200	910	1166	1243	929	1291	1277	951	1254	1347

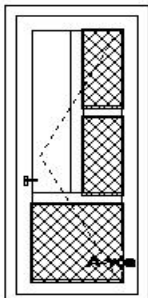

Typ: 22 // 1/3 číre sklo 4/16/4, 2/3 PVC 24mm

Výpočet plochy skla (Ps): $P_s = \check{S}_s \times V_s$ [m²]

$$\check{S}_s = (\check{S}_d \text{ [m]} - 0,366)/2$$

$$V_s = (2 \times V_d \text{ [m]} - 0,67)/3$$

v/š Farba	900			1000			1100		
	Biela	1L	2L	Biela	1L	2L	Biela	1L	2L
2000	866	1099	1169	881	1140	1214	899	1180	1262
2100	873	1117	1191	892	1162	1240	910	1206	1291
2200	881	1140	1214	903	1184	1265	921	1228	1317

Šd - šírka dverí

Vd - výška dverí

Ps - plocha skla

Šs - šírka skla

Vs - výška skla

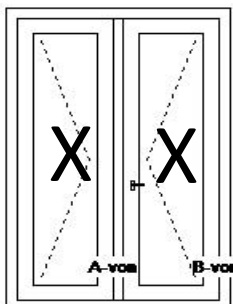

Typ: 23 // dvojkřídlové, bez výplne

Rozmer výplne:

vchodové dvere
 Šk - 270 [mm]
 Vd - 280 [mm]

terasové dvere
 Šk - 220 [mm]
 Vd - 230 [mm]

v/š Farba	1400			1500			1600			1700			1800		
	Biela	1L	2L	Biela	1L	2L	Biela	1L	2L	Biela	1L	2L	Biela	1L	2L
2000	1169	1380	1447	1180	1391	1462	1188	1402	1473	1195	1413	1487	1203	1425	1499
2100	1180	1395	1469	1188	1410	1480	1195	1421	1491	1203	1432	1506	1210	1443	1517
2200	1191	1413	1487	1199	1425	1499	1206	1436	1513	1214	1447	1524	1221	1462	1539

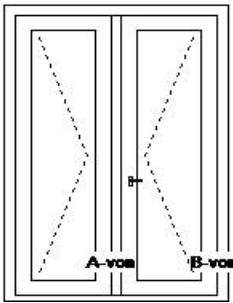

Typ: 24 // dvojkřídlové, číre sklo 4/16/4

Výpočet plochy skla (Ps): $Ps = \check{S}s \times Vs$ [m²]

$\check{S}s = \check{S}d$ [m] - 0,542

$Vs = Vd$ [m] - 0,281

v/š Farba	1400			1500			1600			1700			1800		
	Biela	1L	2L	Biela	1L	2L	Biela	1L	2L	Biela	1L	2L	Biela	1L	2L
2000	1232	1439	1506	1247	1458	1528	1258	1476	1547	1277	1495	1565	1291	1513	1587
2100	1243	1462	1532	1258	1480	1550	1273	1499	1569	1288	1517	1591	1306	1536	1610
2200	1258	1480	1554	1273	1499	1573	1288	1517	1595	1302	1539	1613	1317	1558	1635

Šd - šírka dverí

Vd - výška dverí

Ps - plocha skla

Šs - šírka skla

Vs - výška skla

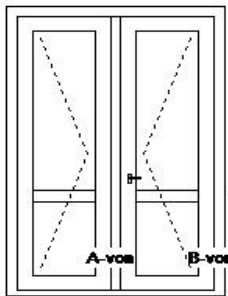

Typ: 25 // dvojkřídlové, číre sklo 4/16/4

Výpočet plochy skla (Ps): $Ps = \check{S}s \times Vs$ [m²]

$\check{S}s = \check{S}d$ [m] - 0,542

$Vs = Vd$ [m] - 0,333

v/š Farba	1400			1500			1600			1700			1800		
	Biela	1L	2L	Biela	1L	2L	Biela	1L	2L	Biela	1L	2L	Biela	1L	2L
2000	1302	1517	1587	1317	1536	1606	1332	1554	1628	1343	1573	1647	1358	1591	1665
2100	1314	1524	1595	1328	1554	1628	1343	1573	1650	1358	1591	1669	1373	1610	1691
2200	1328	1554	1632	1339	1573	1650	1358	1595	1672	1369	1610	1691	1384	1628	1713

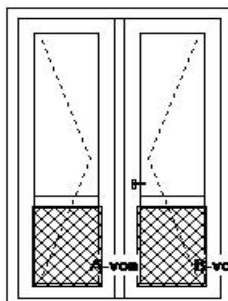

Typ: 26 // dvojkřídlové

2/3 číre sklo 4/16/4, 1/3 PVC 24mm

Výpočet plochy skla (Ps): $Ps = \check{S}s \times Vs$ [m²]

$\check{S}s = \check{S}d$ [m] - 0,542

$Vs = (2 \times Vd$ [m] - 0,67)/3

v/š Farba	1400			1500			1600			1700			1800		
	Biela	1L	2L	Biela	1L	2L	Biela	1L	2L	Biela	1L	2L	Biela	1L	2L
2000	1306	1595	1684	1325	1628	1721	1343	1658	1754	1358	1687	1791	1376	1721	1824
2100	1321	1610	1702	1339	1654	1750	1358	1687	1787	1376	1717	1824	1391	1750	1861
2200	1332	1647	1746	1351	1680	1783	1373	1713	1820	1391	1746	1857	1410	1780	1894

$\check{S}d$ - šírka dverí

Vd - výška dverí

Ps - plocha skla

$\check{S}s$ - šírka skla

Vs - výška skla

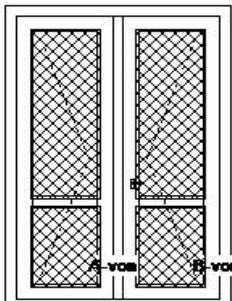

Typ: 27 // dvojkřídlové, PVC 24mm

v/š Farba	1400			1500			1600			1700			1800		
	Biela	1L	2L	Biela	1L	2L	Biela	1L	2L	Biela	1L	2L	Biela	1L	2L
2000	1339	1791	1920	1362	1843	1980	1384	1898	2042	1402	1950	2105	1425	2005	2168
2100	1354	1813	1950	1376	1883	2028	1399	1939	2094	1421	1994	2157	1443	2054	2224
2200	1369	1865	2005	1395	1924	2076	1417	1983	2142	1439	2042	2209	1465	2098	2276

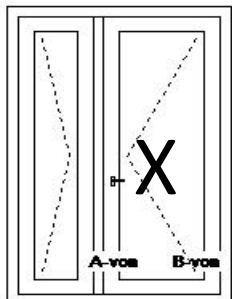

Typ: 28 // dvojkřídlové hlavné křídlo bez výplne vedľajšie křídlo číre sklo 4/16/4

v/š Farba	1400			1500			1600			1700			1800		
	Biela	1L	2L	Biela	1L	2L	Biela	1L	2L	Biela	1L	2L	Biela	1L	2L
2000	1191	1399	1469	1203	1413	1484	1210	1428	1499	1221	1443	1513	1232	1458	1528
2100	1203	1417	1487	1214	1432	1506	1221	1447	1521	1232	1462	1536	1243	1476	1550
2200	1214	1436	1510	1225	1450	1524	1232	1465	1539	1243	1480	1558	1254	1495	1573

X**Svetlík -Fix /Biela/ bez výplne**

Rozmer výplne: Š - 0,102 [m] V - 0,102 [m]

	500	600	700	800	900	1000	1100	1200	1300	1400	1500	1600	1700	1800	1900	2000	2100	2200	2300	2400	2500
300	49	53	55	57	58	60	62	64	66	68	70	71	73	75	77	79	81	83	85	86	88
400	50	54	56	58	60	62	64	66	67	69	71	73	75	77	79	80	82	84	86	88	90
500	52	56	58	60	62	63	65	67	69	71	73	75	76	78	80	82	84	86	88	89	91
600	56	60	62	64	66	68	70	71	73	75	77	79	81	83	84	86	88	90	92	94	96
700	58	62	64	66	68	70	72	74	75	77	79	81	83	85	87	88	90	92	94	96	98
800	60	64	66	68	70	72	74	76	77	79	81	83	85	87	89	90	92	94	96	98	100
900	62	67	68	70	72	74	76	78	80	81	83	85	87	89	91	93	94	96	98	100	102
1000	65	69	70	72	74	76	78	80	82	83	85	87	89	91	93	95	96	98	100	102	104

Svetlík -Fix /1L/ bez výplne

	500	600	700	800	900	1000	1100	1200	1300	1400	1500	1600	1700	1800	1900	2000	2100	2200	2300	2400	2500
300	57	60	62	65	67	69	72	74	77	79	82	84	87	89	92	94	97	99	101	104	106
400	60	62	65	67	70	72	75	77	80	82	84	87	89	92	94	97	99	102	104	107	109
500	63	65	67	70	72	75	77	80	82	85	87	90	92	95	97	99	102	104	107	109	112
600	65	68	70	73	75	78	80	82	85	87	90	92	95	97	100	102	105	107	110	112	114
700	68	70	73	75	78	80	83	85	88	90	93	95	97	100	102	105	107	110	112	115	117
800	71	73	76	78	80	83	85	88	90	93	95	98	100	103	105	108	110	112	115	117	120
900	73	76	78	81	83	86	88	91	93	95	98	100	103	105	108	110	113	115	118	120	123
1000	76	78	81	83	86	88	91	93	96	98	101	103	105	108	110	113	115	118	120	123	125

Svetlík -Fix /2L/ bez výplne

	500	600	700	800	900	1000	1100	1200	1300	1400	1500	1600	1700	1800	1900	2000	2100	2200	2300	2400	2500
300	62	65	68	71	74	78	81	84	87	90	93	96	99	102	106	109	112	115	118	121	124
400	65	68	72	75	78	81	84	87	90	93	96	100	103	106	109	112	115	118	121	124	127
500	69	72	75	78	81	84	87	90	94	97	100	103	106	109	112	115	118	121	125	128	131
600	72	75	78	81	84	88	91	94	97	100	103	106	109	112	116	119	122	125	128	131	134
700	75	78	82	85	88	91	94	97	100	103	106	110	113	116	119	122	125	128	131	134	137
800	79	82	85	88	91	94	97	100	104	107	110	113	116	119	122	125	128	132	135	138	141
900	82	85	88	91	94	98	101	104	107	110	113	116	119	122	126	129	132	135	138	141	144
1000	85	88	92	95	98	101	104	107	110	113	116	120	123	126	129	132	135	138	141	144	147

Svetlík -Fix /Biela/ číre sklo, 4/16/4

Rozmer skla: Š - 0,102 [m] V - 0,102 [m]

	500	600	700	800	900	1000	1100	1200	1300	1400	1500	1600	1700	1800	1900	2000	2100	2200	2300	2400	2500
300	65	69	70	72	74	76	78	80	82	83	85	87	89	91	93	95	96	99	102	104	107
400	66	70	72	74	76	78	79	81	83	85	88	91	94	97	100	103	106	109	112	115	118
500	68	72	74	75	77	79	81	84	88	91	95	98	102	105	108	112	115	119	122	125	129
600	72	76	78	80	82	85	89	93	97	101	104	108	112	116	120	124	127	131	135	138	142
700	74	78	80	83	87	91	95	99	104	108	112	116	120	125	129	133	137	141	145	150	154
800	76	80	83	87	92	97	101	106	110	115	120	124	129	133	138	142	147	151	156	161	165
900	78	82	87	92	97	102	107	112	117	122	127	132	137	142	147	152	157	162	167	172	177
1000	80	86	92	97	102	108	113	119	124	129	135	140	146	151	156	161	167	172	177	183	188

Svetlík -Fix /1L/ číre sklo, 4/16/4

	500	600	700	800	900	1000	1100	1200	1300	1400	1500	1600	1700	1800	1900	2000	2100	2200	2300	2400	2500
300	73	75	78	80	83	85	88	90	93	95	97	100	102	105	107	110	112	115	119	122	125
400	76	78	80	83	85	88	90	93	95	98	101	105	108	112	115	119	123	126	130	133	137
500	78	81	83	86	88	91	93	97	101	105	109	113	117	121	125	129	133	137	141	145	149
600	81	83	86	88	91	95	100	104	108	113	117	122	126	131	135	139	144	148	152	157	161
700	84	86	89	92	97	101	106	111	116	121	125	130	135	140	145	150	154	159	164	168	173
800	86	89	92	97	102	108	113	118	123	128	134	139	144	149	155	159	165	170	175	180	185
900	89	91	97	103	108	114	119	125	131	136	142	147	153	159	164	169	175	181	186	192	197
1000	92	96	102	108	114	120	126	132	138	144	150	156	162	168	174	180	186	192	198	204	210

Svetlík -Fix /2L/ číre sklo, 4/16/4

	500	600	700	800	900	1000	1100	1200	1300	1400	1500	1600	1700	1800	1900	2000	2100	2200	2300	2400	2500
300	78	81	84	87	90	93	96	99	103	106	109	112	115	118	121	124	127	131	135	139	143
400	81	84	87	90	93	97	100	103	106	109	113	117	121	126	130	134	139	143	147	151	155
500	84	87	91	94	97	100	103	108	112	117	122	126	131	136	140	145	150	154	159	163	168
600	88	91	94	97	100	105	110	115	120	126	131	136	141	146	151	156	161	166	171	176	181
700	91	94	97	101	107	112	118	123	128	134	139	145	150	156	161	167	172	177	183	188	194
800	94	97	101	107	113	119	125	131	137	142	148	154	160	166	172	177	183	189	195	201	206
900	98	101	107	113	120	126	132	138	145	151	157	163	170	176	182	188	194	200	207	213	219
1000	101	106	113	119	126	133	139	146	153	159	166	172	179	185	192	199	205	212	219	225	232

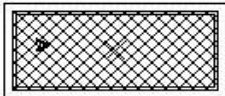

Svetlík -Fix /Biela/ pvc výplň 24mm

	500	600	700	800	900	1000	1100	1200	1300	1400	1500	1600	1700	1800	1900	2000	2100	2200	2300	2400	2500
300	55	60	64	67	70	74	77	80	84	87	90	94	97	100	104	107	110	114	117	120	124
400	59	66	70	74	78	82	86	90	94	98	102	106	110	115	119	123	127	131	135	139	143
500	64	71	76	80	85	90	95	100	105	109	114	119	124	129	133	138	143	148	153	158	162
600	71	79	84	90	96	101	107	112	118	123	129	135	140	146	151	157	162	168	173	179	185
700	76	85	91	97	104	110	116	122	129	135	141	148	154	160	167	173	179	186	192	198	205
800	81	90	97	105	112	119	126	133	140	147	154	161	168	175	182	189	196	203	210	218	225
900	86	96	104	112	120	127	135	143	151	159	166	174	182	190	198	205	213	221	229	237	245
1000	91	102	111	119	128	136	145	153	162	170	179	188	196	205	213	222	230	239	247	256	264

Svetlík -Fix /1L/ pvc výplň 24mm

	500	600	700	800	900	1000	1100	1200	1300	1400	1500	1600	1700	1800	1900	2000	2100	2200	2300	2400	2500
300	76	83	91	98	105	112	120	127	134	141	148	156	163	170	177	185	192	199	206	213	221
400	88	98	108	117	127	137	146	156	165	175	185	194	204	214	223	233	243	252	262	271	281
500	101	113	125	137	149	161	173	185	197	209	221	233	245	257	269	281	293	305	317	329	341
600	113	127	142	156	171	185	200	214	229	243	257	272	286	301	315	330	344	359	373	387	402
700	125	142	159	176	193	209	226	243	260	277	294	311	327	344	361	378	395	412	429	445	462
800	137	157	176	195	215	234	253	272	292	311	330	349	369	388	407	426	446	465	484	503	523
900	150	171	193	215	236	258	280	301	323	345	366	388	410	431	453	475	496	518	540	561	583
1000	162	186	210	234	258	282	306	331	355	379	403	427	451	475	499	523	547	571	595	619	643

Svetlík -Fix /2L/ pvc výplň 24mm

	500	600	700	800	900	1000	1100	1200	1300	1400	1500	1600	1700	1800	1900	2000	2100	2200	2300	2400	2500
300	84	93	102	110	119	128	136	145	154	162	171	180	188	197	206	214	223	232	240	249	258
400	99	110	122	133	145	156	168	179	191	202	214	225	237	248	260	271	283	294	306	317	329
500	113	128	142	156	170	185	199	213	228	242	256	271	285	299	314	328	342	356	371	385	399
600	128	145	162	179	196	213	231	248	265	282	299	316	333	350	367	385	402	419	436	453	470
700	142	162	182	202	222	242	262	282	302	322	342	362	381	401	421	441	461	481	501	521	541
800	157	180	202	225	248	271	293	316	339	362	384	407	430	453	475	498	521	544	566	589	612
900	171	197	223	248	274	299	325	350	376	401	427	453	478	504	529	555	580	606	631	657	683
1000	186	214	243	271	299	328	356	385	413	441	470	498	526	555	583	611	640	668	697	725	753

Svetlík -Fix /Biela/ 2/3 číre sklo 4/16/4, 1/3 PVC 24mm

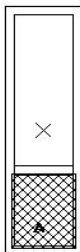

	1500	1600	1700	1800	1900	2000	2100	2200	2300	2400	2500
300	118	120	123	125	127	130	132	134	137	139	141
400	124	127	129	132	134	137	140	143	146	149	153
500	130	133	137	140	144	148	152	156	160	164	168
600	141	145	150	154	159	163	167	172	176	180	185
700	151	156	161	166	171	176	181	186	191	196	200
800	161	167	172	178	183	188	194	199	205	210	215
900	171	177	184	189	195	201	207	213	219	225	231
1000	181	188	194	201	207	214	220	227	233	240	246

Výpočet plochy skla:
(Ps): $Ps = \check{S}s \times Vs$ [m²]

$\check{S}s = \check{S}$ [m] - 0,102

$Vs = (2 \times v$ [m] - 0,308)/3

Svetlík -Fix /1L/ 2/3 číre sklo 4/16/4, 1/3 PVC 24mm

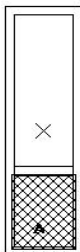

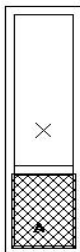

	1500	1600	1700	1800	1900	2000	2100	2200	2300	2400	2500
300	145	149	154	158	162	166	170	174	178	182	186
400	160	165	170	175	180	184	189	195	200	206	211
500	174	181	187	194	200	207	214	221	227	234	241
600	191	200	208	216	223	231	238	246	254	262	270
700	209	219	228	237	246	255	264	272	281	290	299
800	228	239	249	259	268	278	288	298	308	318	328
900	246	258	269	280	291	302	313	324	335	346	357
1000	264	278	290	302	314	326	338	350	362	374	386

Svetlík -Fix /2L/ 2/3 číre sklo 4/16/4, 1/3 PVC 24mm

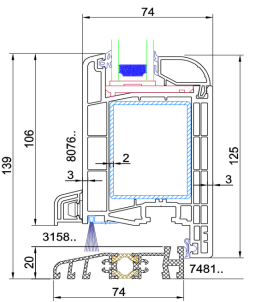
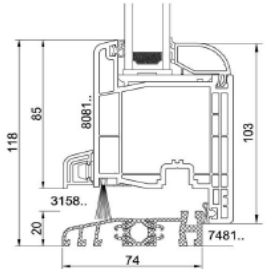
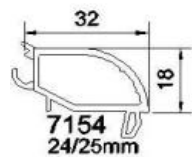
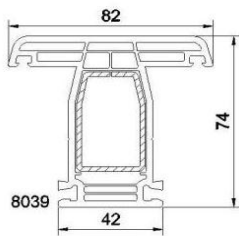
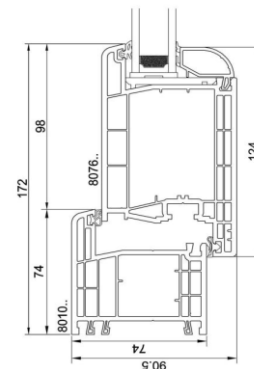
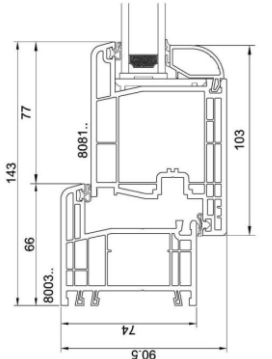

	1500	1600	1700	1800	1900	2000	2100	2200	2300	2400	2500
300	160	166	171	176	181	186	191	196	201	205	210
400	178	184	190	196	202	208	214	220	227	233	240
500	195	203	210	218	226	234	242	250	258	265	273
600	215	225	234	243	252	261	270	279	288	297	307
700	236	247	258	268	278	288	299	309	319	330	340
800	256	269	281	293	304	315	327	338	350	361	373
900	278	292	305	317	330	343	355	368	381	393	406
1000	299	314	328	342	356	370	384	398	411	425	439

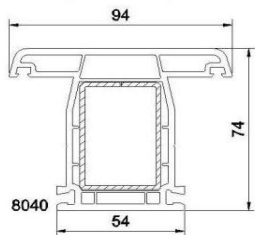
Vchodové dvere GEALAN IQ8000	Terasové dvere GEALAN IQ8000	Zasklievacie lišty	Priečka	
				
		 	<th data-bbox="1110 560 1445 616">Stípič</th> 	Stípič

HERPlast

027 47 Oravská Polhora

dvere@herplast.eu

IČO: 38732290

DIČ: 2022327626

IČDPH:

veľkoobchod plastových okien a dverí

SK2022327626

TEL: 0915 879 645, TEL/FAX: 043 / 5595 050, 043 / 5595 484, 043 / 5595 207

OBJEDNÁVKA vchodových dverí

Odberateľ:

Adresa:

Dátum:

Profil <input type="checkbox"/> Gealan <input type="checkbox"/> Aluplast <input type="checkbox"/> Salamander	Nákras vchodových dverí pri podlahe Z VNUTRA
Farba Z vontra Z vonku	
Otváranie <input type="checkbox"/> Dnu <input type="checkbox"/> Von	
Spôsob otvárania <input type="checkbox"/> Kľučka/Kľučka <input type="checkbox"/> Gai'a/Kľučka <input type="checkbox"/> Samozatvárac <input type="checkbox"/> Elektrický vrátnik <input type="checkbox"/> Madlo	
Zaujímavé <input type="checkbox"/> 4 ⁽¹⁾ -bodový excenlger (standard) ⁽⁴⁾ <input type="checkbox"/> 4-bodový excenler ⁽³⁾ <input type="checkbox"/> 3-bodový (2x Háky) manual ⁽⁴⁾ <input type="checkbox"/> 3-bodový (2x Háky) ⁽³⁾ <input type="checkbox"/> 3 ⁽²⁾ strečky + jazýček automat	
Vypň (strážik) <input type="checkbox"/> Čire skló <input type="checkbox"/> Dubová kóna <input type="checkbox"/> Mliecne skló <input type="checkbox"/> Stoposl <input type="checkbox"/>	
Vypň (strežik)	
Poznámky:	

(1)-excenlre platiná pre všetky profily

(2)-automatické uzatvorenie dverí v troch bodoch

(3)-ide o zaujímavé číto lan kľučkom

(4)-ide o zaujímavé poťahovanie kľučky dohora



027 47 Oravská Polhora

herplast@herplast.eu

ICO: 38732290

OIC: 2022327626

ICDPH:

SK202327626

veľkoobchod plastových okien a dverí

TEL: 0917 581 003, TEL/FAX: 043 / 5595 050, 043 / 5595 484, 043 / 5595 207

CENOVÁ PONUKA vhodových dverí

Objemiel:

Akcia:

Datum:

Profil	<input type="checkbox"/> Gealan <input type="checkbox"/> Aluplast <input type="checkbox"/> Salamander	Náves vhodových dverí pri pohľade Z VŮTRÁ
Farba	Z vnútra	
	Z vonku	
Otváranie	<input type="checkbox"/> Dnu <input type="checkbox"/> Von	
Spôsob otvárania	<input type="checkbox"/> Kľučka/Kľučka <input type="checkbox"/> Gula/Kľučka <input type="checkbox"/> Samozatvárac <input type="checkbox"/> Elektrický vrátnik <input type="checkbox"/> Madlo	
Zamykanie	<input type="checkbox"/> 4 ⁽¹⁾ -bodový excenter (standard) ⁽⁴⁾ <input type="checkbox"/> 4-bodový excenter ⁽²⁾ <input type="checkbox"/> 3-bodový (2x Háky) ⁽³⁾ manuál ⁽⁴⁾ <input type="checkbox"/> 3-bodový (2x Háky) ⁽³⁾ <input type="checkbox"/> 3 ⁽²⁾ strelky + jazýček automat	
Výplň (kvalita)	<input type="checkbox"/> Číre sklo <input type="checkbox"/> Dubová kôra <input type="checkbox"/> Miliečne sklo <input type="checkbox"/> Stopsol <input type="checkbox"/>	
Výplň (svetlô)	
Poznámky:		

(1)-excentre plnia pre všetky profily

(2)-automatické uzatvorenie dverí v troch bodoch

(3)-ide o zamykanie číro len kľúčkom

(4)-ide o zamykanie poháňaním kľučky dohora